

N-Channel Enhancement Mode Field Effect Transistor

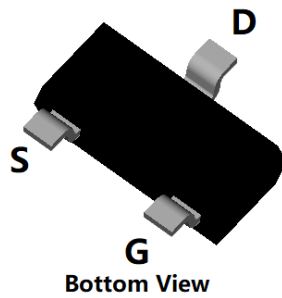

SOT-23

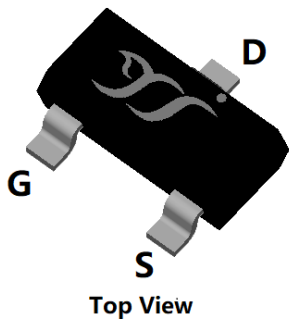
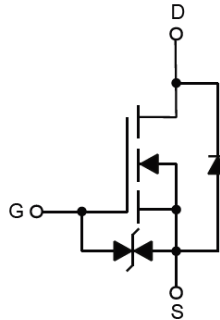

Product Summary

- V_{DS} 60V
- I_D 300mA
- $R_{DS(ON)}$ (at $V_{GS}=10V$) <2.0ohm
- $R_{DS(ON)}$ (at $V_{GS}=4.5V$) <2.5ohm
- ESD protected up to 2.0KV (HBM)

General Description

- Trench Power MV MOSFET technology
- Voltage controlled small signal switch
- Low input Capacitance
- Fast Switching Speed
- Low Input / Output Leakage
- Part no. with suffix "Q" means AEC-Q101 qualified

Applications

- Battery operated systems
- Solid-state relays
- Direct logic-level interface: TTL/CMOS
- 12V, 24V Automotive systems

■ Absolute Maximum Ratings ($T_A=25^\circ C$ unless otherwise noted)

Parameter	Symbol	Limit	Unit
Drain-source Voltage	V_{DS}	60	V
Gate-source Voltage	V_{GS}	± 20	V
Drain Current @ $T_A=25^\circ C$	I_D	300	mA
Pulsed Drain Current ^A	I_{DM}	1.5	A
Total Power Dissipation @ $T_A=25^\circ C$	P_D	520	mW
Thermal Resistance Junction-to-Ambient @ Steady State ^B	$R_{\theta JA}$	285	$^\circ C/W$
Junction and Storage Temperature Range	T_J, T_{STG}	-55~+175	$^\circ C$

■ Ordering Information (Example)

PREFERRED P/N	PACKING CODE	Marking	MINIMUM PACKAGE(pcs)	INNER BOX QUANTITY(pcs)	OUTER CARTON QUANTITY(pcs)	DELIVERY MODE
2N7002KDHQ	F2	72KD.	3000	30000	120000	7" reel



2N7002KDHQ

■ Electrical Characteristics (T_J=25°C unless otherwise noted)

Parameter	Symbol	Conditions	Min	Typ	Max	Units
Static Parameter						
Drain-Source Breakdown Voltage	BV _{DSS}	V _{GS} =0V, I _D =250μA	60			V
Zero Gate Voltage Drain Current	I _{DSS}	V _{DS} =60V, V _{GS} =0V			1	μA
Gate-Body Leakage Current	I _{GSS}	V _{GS} = ±20V, V _{DS} =0V			±10	μA
Gate Threshold Voltage	V _{GS(th)}	V _{DS} = V _{GS} , I _D =250μA	1.1	1.5	2.4	V
Static Drain-Source On-Resistance	R _{DS(on)}	V _{GS} = 10V, I _D =300mA		1.1	2.0	Ω
		V _{GS} = 4.5V, I _D =200mA		1.3	2.5	
Diode Forward Voltage	V _{SD}	I _S =115mA, V _{GS} =0V		0.9	1.2	V
Gate resistance	R _G	f=1MHz		150		Ω
Dynamic Parameters						
Input Capacitance	C _{iss}	V _{DS} =25V, V _{GS} =0V, f=1MHz		25		pF
Output Capacitance	C _{oss}			8		
Reverse Transfer Capacitance	C _{rss}			4		
Switching Parameters						
Total Gate Charge	Q _g	V _{GS} =10V, V _{DS} =30V, I _D =1A		1.75		nC
Gate Source Charge	Q _{gs}			1.00		
Gate Drain Charge	Q _{gd}			0.25		
Reverse Recovery Charge	Q _{rr}	I _{SD} =1A, di/dt=100A/us		3.9		nC
Reverse Recovery Time	t _{rr}			15		ns
Turn-on Delay Time	t _{D(on)}	V _{GS} =10V, V _{DS} =30V, I _D =1A, R _g =3Ω		4.6		ns
Turn-on Rise Time	t _r			20.0		
Turn-off Delay Time	t _{D(off)}			10.5		
Turn-off Fall Time	t _f			25.5		

A. Repetitive rating; pulse width limited by max. junction temperature.

B. The value of R_{θJA} is measured with the device mounted on the minimum recommend pad size, in the still air environment with T_A=25°C. The maximum allowed junction temperature of 175°C. The value in any given application depends on the user's specific board design.



2N7002KDHQ

■ Typical Performance Characteristics

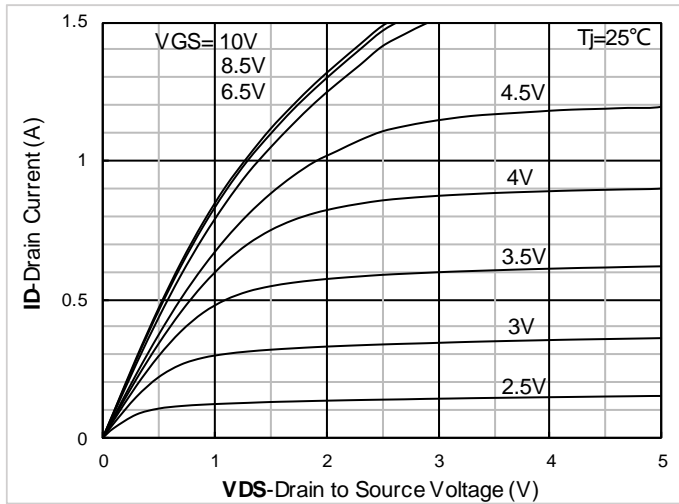

Figure1. Output Characteristics

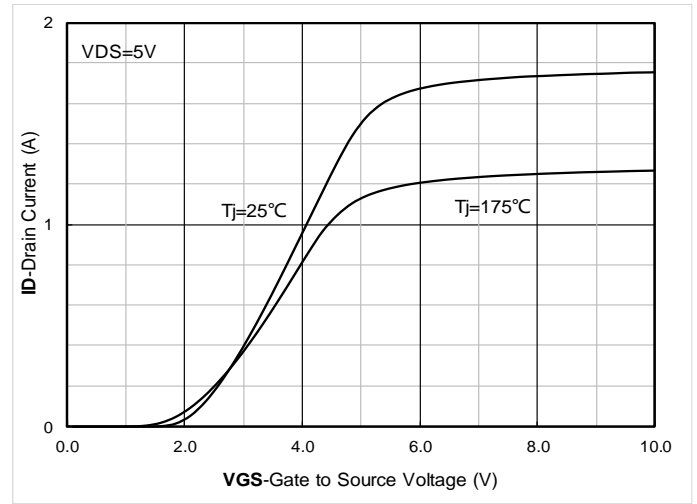

Figure2. Transfer Characteristics

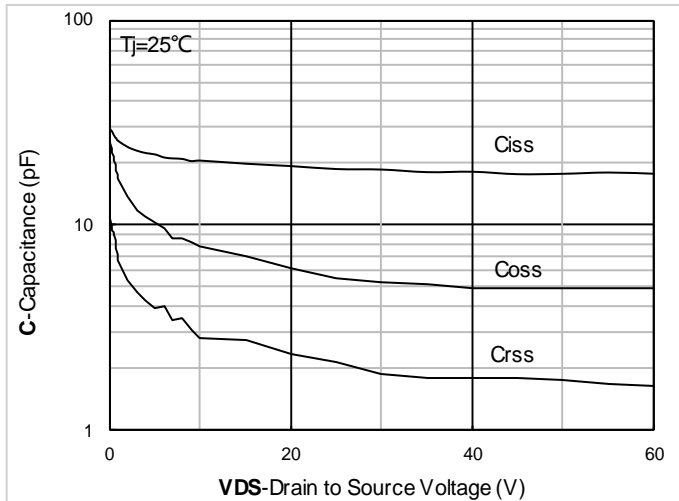

Figure3. Capacitance Characteristics

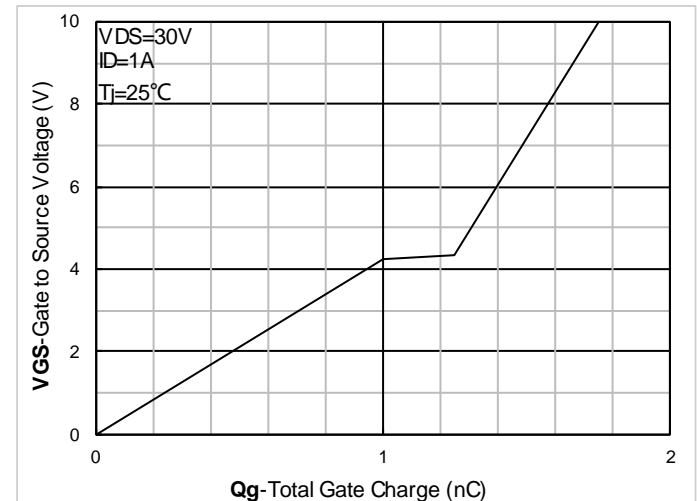

Figure4. Gate Charge

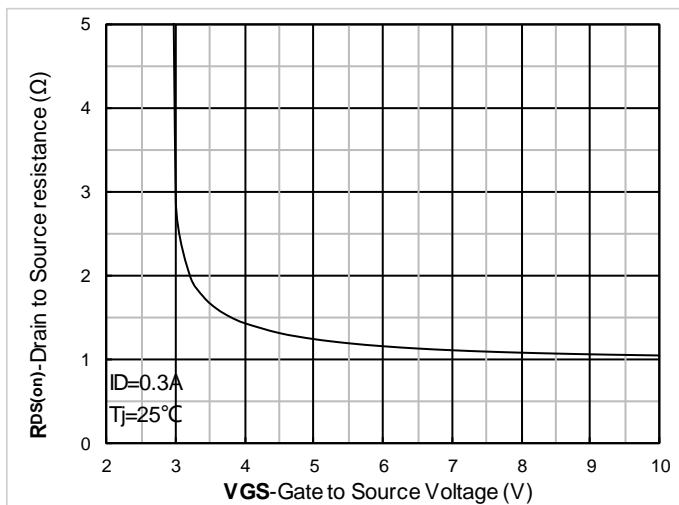

Figure5. On-Resistance vs Gate to Source Voltage

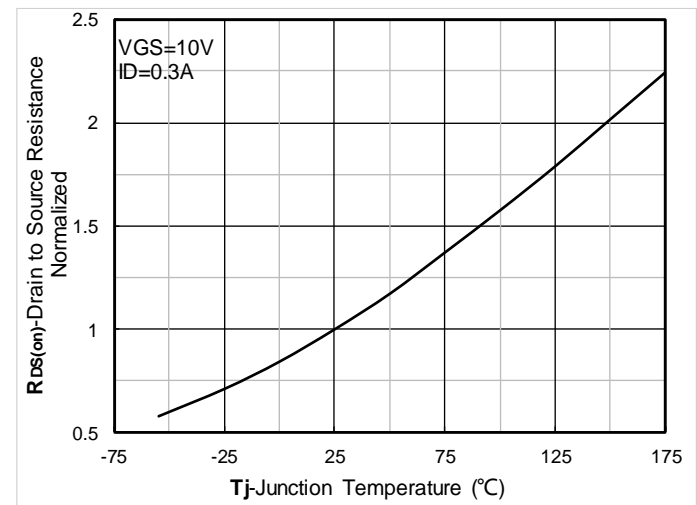

Figure6. Normalized On-Resistance



2N7002KDHQ

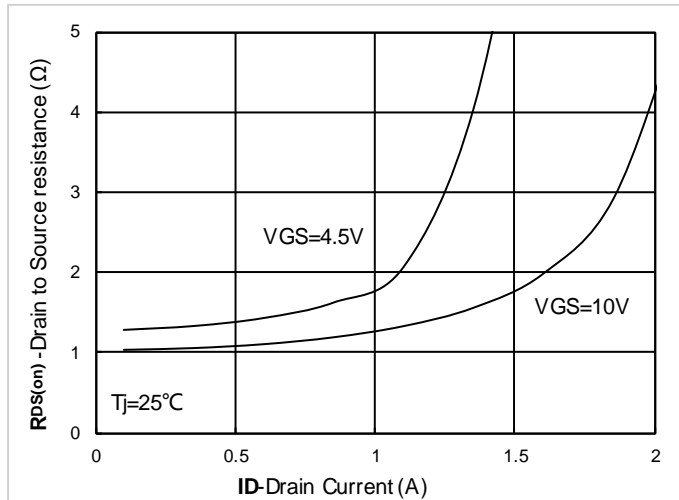

Figure 7. $R_{DS(on)}$ VS Drain Current

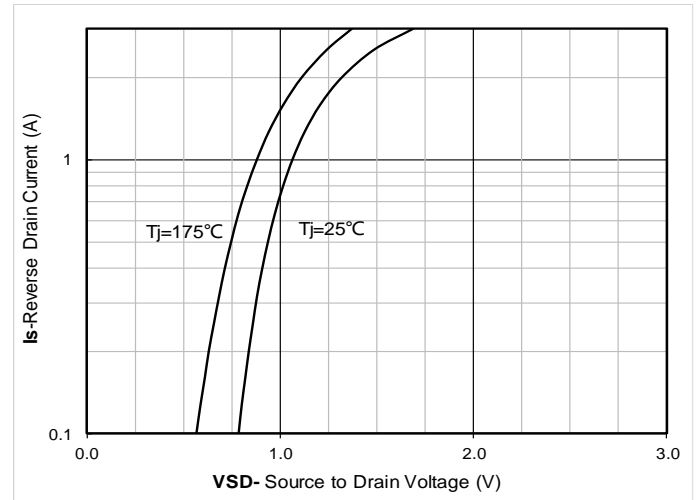

Figure 8. Forward characteristics of reverse diode

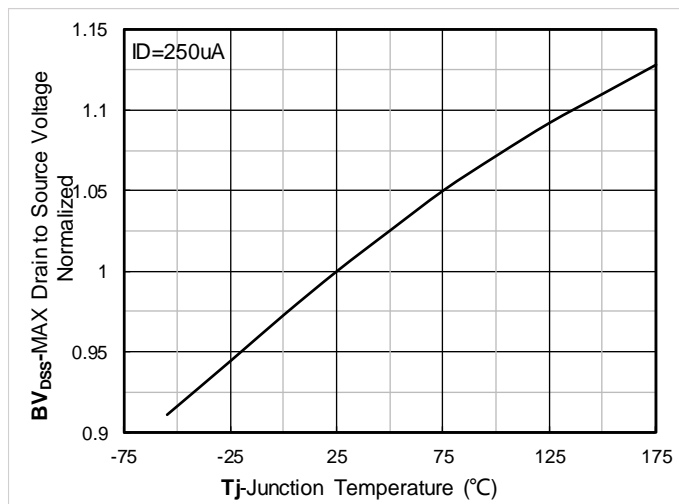

Figure 9. Normalized breakdown voltage

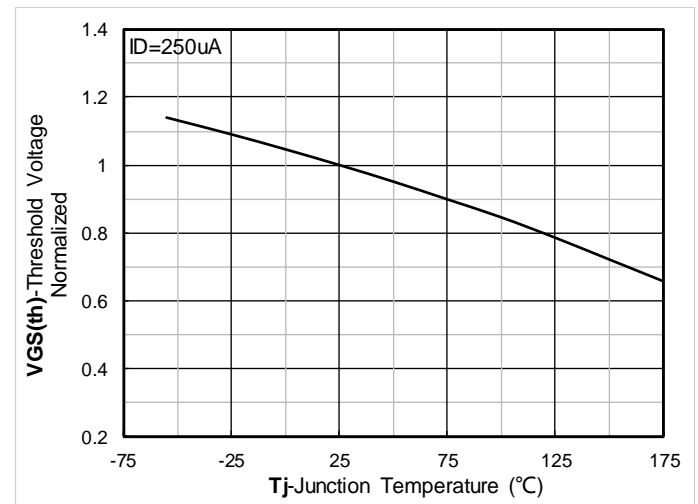

Figure 10. Normalized Threshold voltage

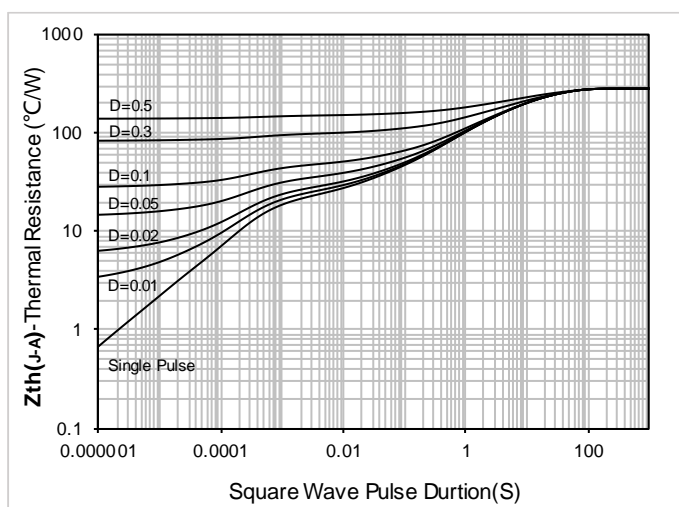

Figure 11. Maximum Transient Thermal Impedance

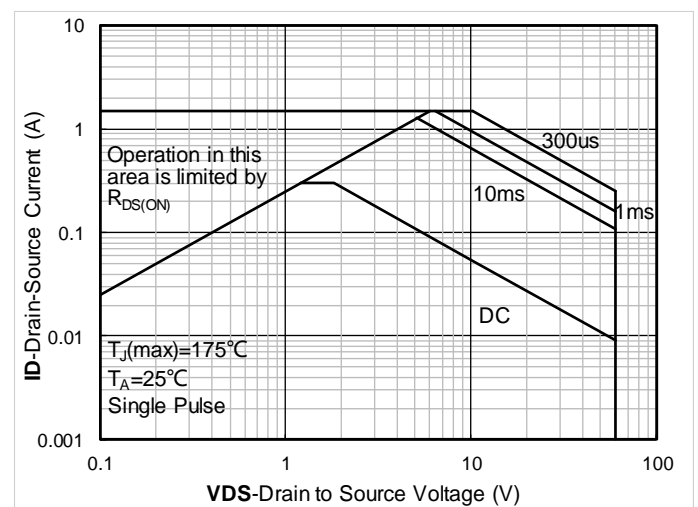

Figure 12. Safe Operation Area

■ Test Circuits & Waveforms

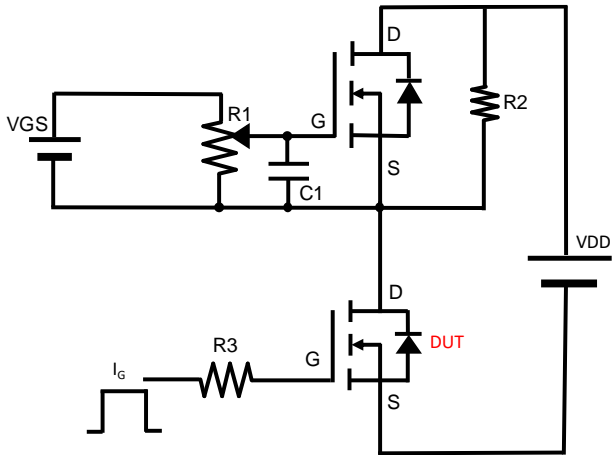

Figure A. Gate Charge Test Circuit & Waveform

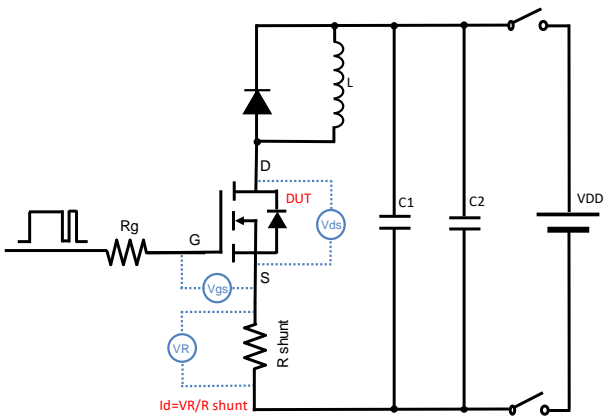

Figure B. Resistive Switching Test Circuit & Waveform

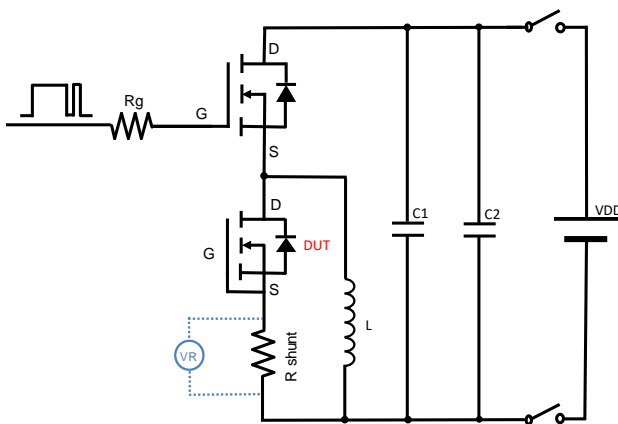
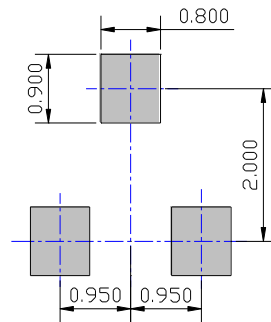
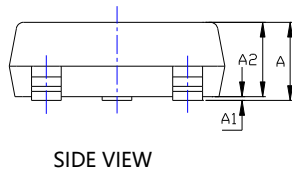
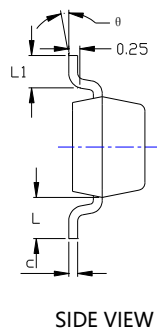
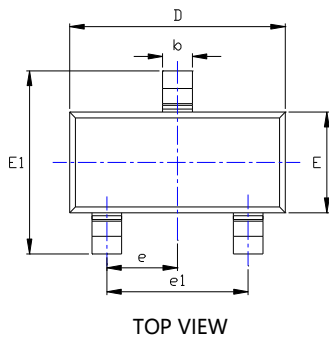

Figure C. Diode Recovery Test Circuit & Waveform



2N7002KDHQ

■ SOT-23 Package Outline Dimensions



UNIT: mm

SYMBOL	DIMENSIONS			
	INCHES		Millimeter	
	MIN.	MAX.	MIN.	MAX.
A	0.035	0.045	0.900	1.150
A1	0.000	0.004	0.000	0.100
A2	0.035	0.041	0.900	1.050
b	0.012	0.020	0.300	0.500
c	0.004	0.008	0.100	0.200
D	0.110	0.118	2.800	3.000
E	0.047	0.055	1.200	1.400
E1	0.089	0.100	2.250	2.550
e	0.037TYP		0.950TYP	
e1	0.071	0.079	1.800	2.000
L	0.022REF		0.550REF	
L1	0.012	0.020	0.300	0.500
θ	0°	8°	0°	8°

NOTE:
 1. PACKAGE BODY SIZES EXCLUDE MOLD FLASH AND GATE BURRS.
 2. TOLERANCE 0.1mm UNLESS OTHERWISE SPECIFIED.
 3. THE PAD LAYOUT IS FOR REFERENCE PURPOSES ONLY.

■ Marking Information

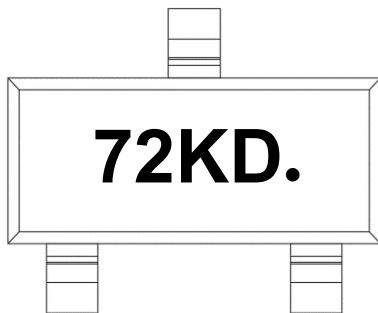

Note:

1. All marking is at middle of the product body
2. All marking is in laser marking
3. 72KD is Marking Code
4. Body color: Black



2N7002KDHQ

Disclaimer

The information presented in this document is for reference only. Yangzhou Yangjie Electronic Technology Co., Ltd. reserves the right to make changes without notice for the specification of the products displayed herein to improve reliability, function or design or otherwise.

The product listed herein is designed to be used with automotive electronics. They are not designed for use in medical, life-saving, life-sustaining, or military, Yangjie or anyone on its behalf, assumes no responsibility or liability for any damages resulting from such improper use of sale.

This publication supersedes & replaces all information previously supplied. For additional information, please visit our website [http:// www.21yangjie.com](http://www.21yangjie.com) , or consult your nearest Yangjie's sales office for further assistance.