

## N-Channel Enhancement Mode Field Effect Transistor

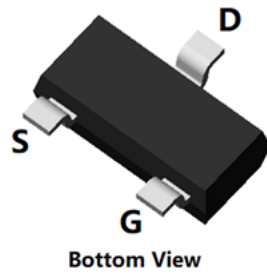

**SOT-23**

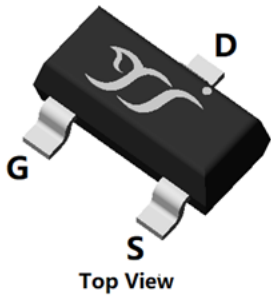
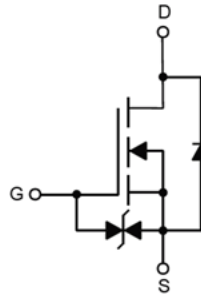

### Product Summary

- $V_{DS}$  30V
- $I_D$  4.3A
- $R_{DS(ON)}$  (at  $V_{GS}=4.5V$ )  $<31m\Omega$
- $R_{DS(ON)}$  (at  $V_{GS}=2.5V$ )  $<41m\Omega$
- ESD Protected Up to 2KV (HBM)

### General Description

- Trench Power LV MOSFET technology
- High density cell design for low  $R_{DS(ON)}$
- Moisture Sensitivity Level 1
- Epoxy Meets UL 94 V-0 Flammability Rating
- Halogen Free

### Applications

- Battery protection
- Load switch
- Power management

### Limiting Values

Parameter	Conditions	Symbol	Min	Max	Unit	
Drain-source Voltage		$V_{DS}$	-	30	V	
Gate-source Voltage		$V_{GS}$	-12	12		
Continuous Drain Current (Note 1,2)	Steady-State	$I_D$	$T_A=25^\circ C, V_{GS}=4.5V$	-	4.3	A
			$T_A=100^\circ C, V_{GS}=4.5V$	-	2.7	
Pulsed Drain Current	$T_C=25^\circ C, t_p \leq 10\mu s$	$I_{DM}$	-	34		
Maximum Body-Diode Continuous Current	$T_C=25^\circ C$	$I_S$		1.25		
Total Power Dissipation (Note 1,2)	Steady-State	$P_D$	$T_A=25^\circ C$	-	1	W
			$T_A=100^\circ C$	-	0.4	
Junction and Storage Temperature Range		$T_J, T_{STG}$	-55	150	$^\circ C$	

### Thermal Resistance

Parameter	Symbol	Typ	Max	Units
Thermal Resistance Junction-to-Ambient (Note 2)	$R_{\theta JA}$	-	125	$^\circ C/W$

### Ordering Information (Example)

PREFERRED P/N	PACKING CODE	Marking	MINIMUM PACKAGE(pcs)	INNER BOX QUANTITY(pcs)	OUTER CARTON QUANTITY(pcs)	DELIVERY MODE
YJL3400AKJ	F2	R4K	3000	30000	120000	7" reel



# YJL3400AKJ

## ■ Electrical Characteristics

Parameter	Symbol	Conditions	Min	Typ	Max	Units
<b>Static Parameter</b>						
Drain-Source Breakdown Voltage	$BV_{DSS}$	$V_{GS}=0V, I_D=250\mu A, T_j=25^\circ C$	30	-	-	V
Zero Gate Voltage Drain Current	$I_{DSS}$	$V_{DS}=24V, V_{GS}=0V, T_j=25^\circ C$	-	-	1	$\mu A$
		$V_{DS}=24V, V_{GS}=0V, T_j=150^\circ C$	-	-	100	
Gate-Source Leakage Current	$I_{GSS}$	$V_{GS}=\pm 12V, V_{DS}=0V, T_j=25^\circ C$	-	-	$\pm 10$	
Gate Threshold Voltage	$V_{GS(th)}$	$V_{DS}=V_{GS}, I_D=250\mu A, T_j=25^\circ C$	0.5	0.9	1.4	V
Static Drain-Source On-Resistance	$R_{DS(on)}$	$V_{GS}=4.5V, I_D=4.3A, T_j=25^\circ C$	-	24	31	$m\Omega$
		$V_{GS}=2.5V, I_D=3A, T_j=25^\circ C$	-	30	41	$m\Omega$
Diode Forward Voltage	$V_{SD}$	$I_S=4.3A, V_{GS}=0V, T_j=25^\circ C$	-	0.79	1.2	V
Gate Resistance	$R_G$	$f=1MHz, T_j=25^\circ C$	-	3	-	$\Omega$
<b>Dynamic Parameters</b>						
Input Capacitance	$C_{iss}$	$V_{DS}=15V, V_{GS}=0V, f=1MHz, T_j=25^\circ C$	-	576	-	$pF$
Output Capacitance	$C_{oss}$		-	61	-	
Reverse Transfer Capacitance	$C_{rss}$		-	43	-	
<b>Switching Parameters</b>						
Total Gate Charge	$Q_g$	$V_{GS}=4.5V, V_{DS}=15V, I_D=3A, T_j=25^\circ C$	-	6.1	-	$nC$
Gate-Source Charge	$Q_{gs}$		-	1.4	-	
Gate-Drain Charge	$Q_{gd}$		-	1.4	-	
Reverse Recovery Charge	$Q_{rr}$	$I_F=3A, di/dt=100A/\mu s, V_{GS}=0V, V_R=15V, T_j=25^\circ C$	-	5	-	$nC$
Reverse Recovery Time	$t_{rr}$		-	10	-	ns
Turn-on Delay Time	$t_{D(on)}$	$V_{GS}=4.5V, V_{DS}=15V, I_D=3A, R_{GEN}=2.7\Omega, T_j=25^\circ C$	-	10	-	$ns$
Turn-on Rise Time	$t_r$		-	24	-	
Turn-off Delay Time	$t_{D(off)}$		-	120	-	
Turn-off Fall Time	$t_f$		-	6	-	

### Note:

- The entire application environment impacts the thermal resistance values shown, they are not constants and are only valid for the particular conditions noted.
- The value of  $R_{\theta JA}$  is measured with the device mounted on the 40mm\*40mm\*1.1mm single layer FR-4 PCB board with 1 in<sup>2</sup> pad of 2oz. Copper, in the still air environment with  $T_A=25^\circ C$ . The maximum allowed junction temperature of  $150^\circ C$ . The value in any given application depends on the user's specific board design.



## Typical Electrical and Thermal Characteristics Diagrams

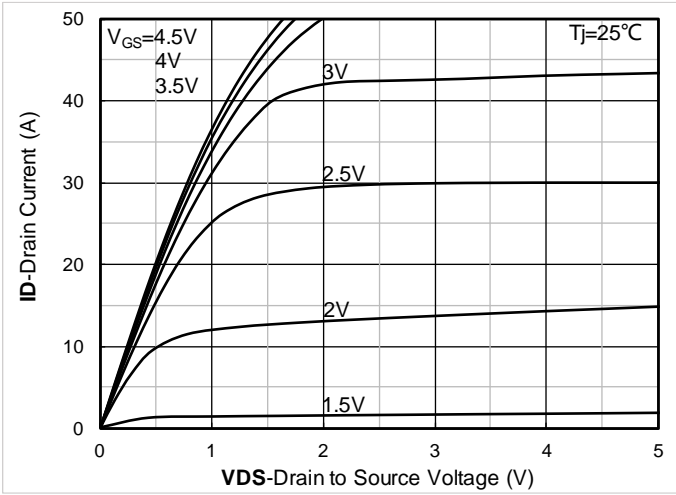

Figure 1. Output Characteristics; typical values

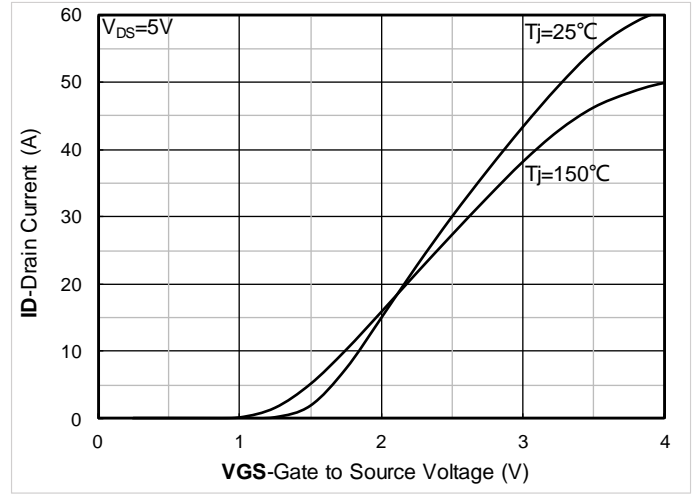

Figure 2. Transfer Characteristics; typical values

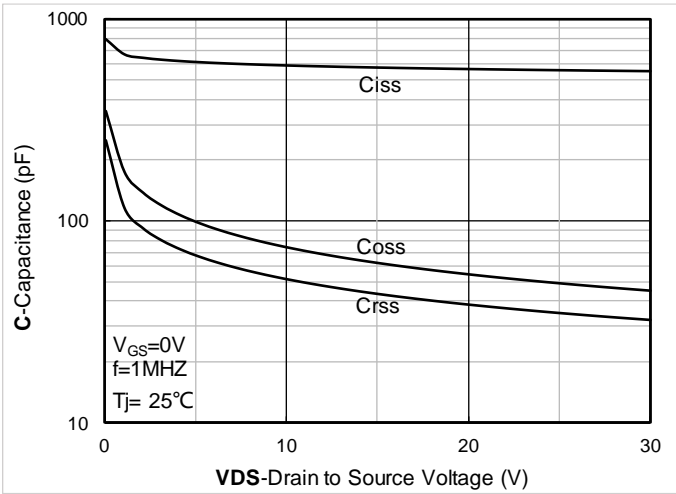

Figure 3. Capacitance Characteristics; typical values

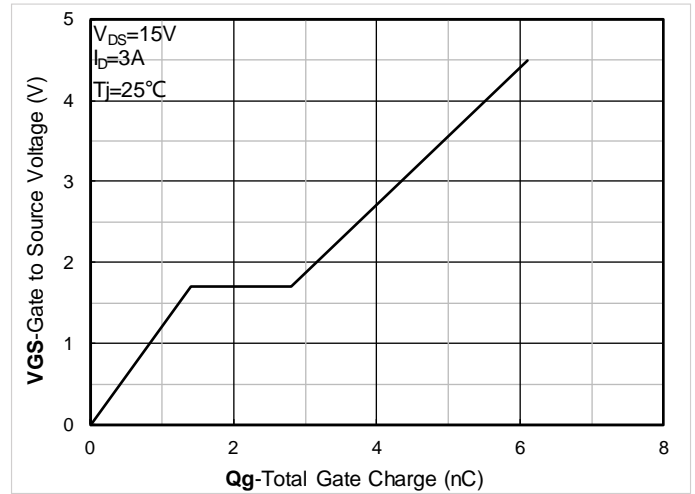

Figure 4. Gate Charge; typical values

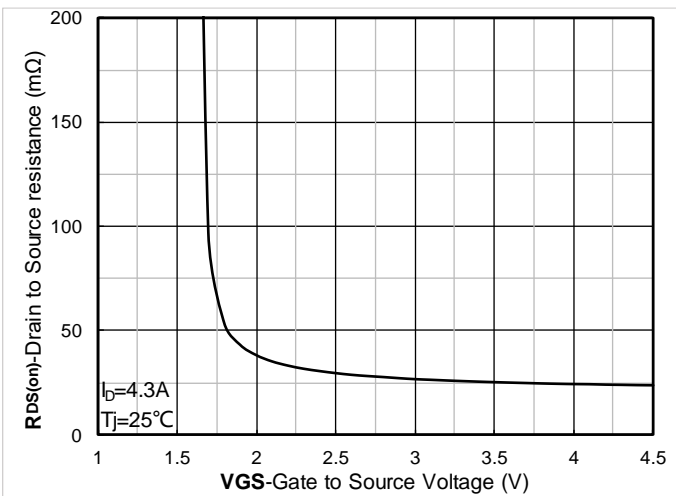

Figure 5. On-Resistance vs. Gate to Source Voltage; typical values

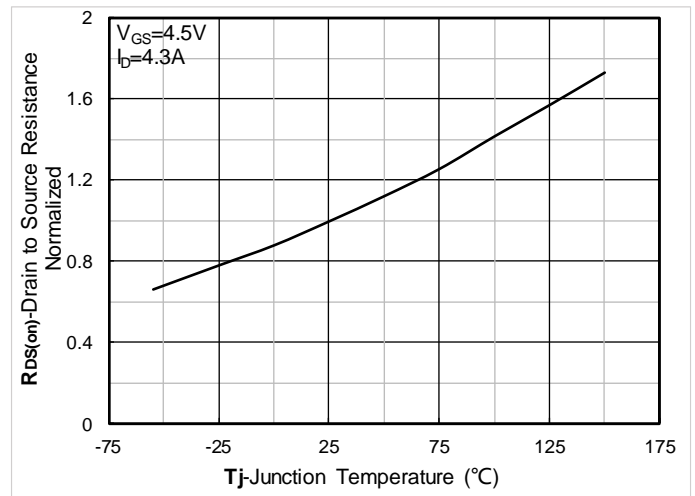

Figure 6. Normalized On-Resistance



# YJL3400AKJ

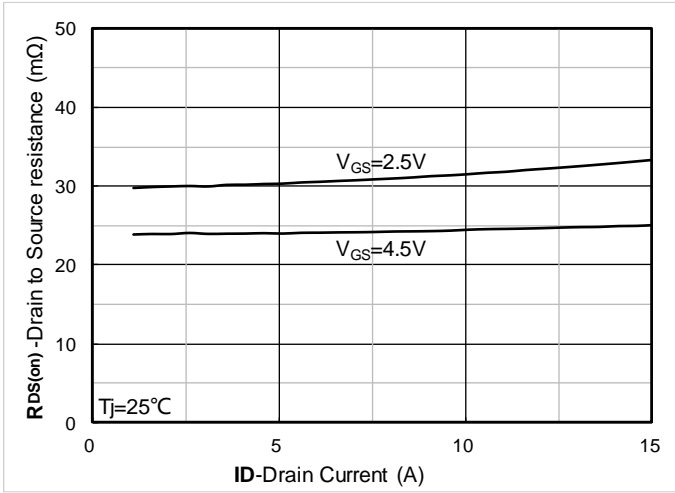

Figure 7. RDS(on) vs. Drain Current; typical values

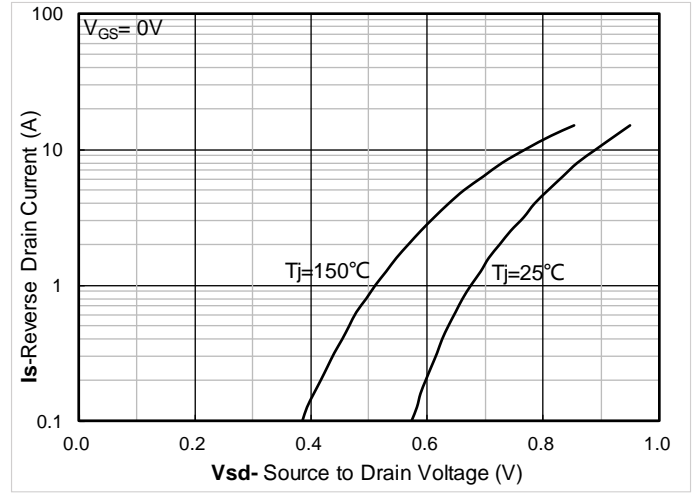

Figure 8. Forward characteristics of reverse diode; typical values

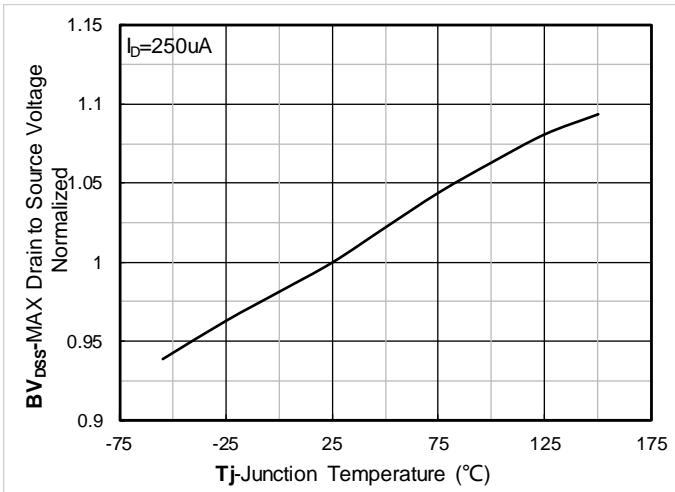

Figure 9. Normalized breakdown voltage

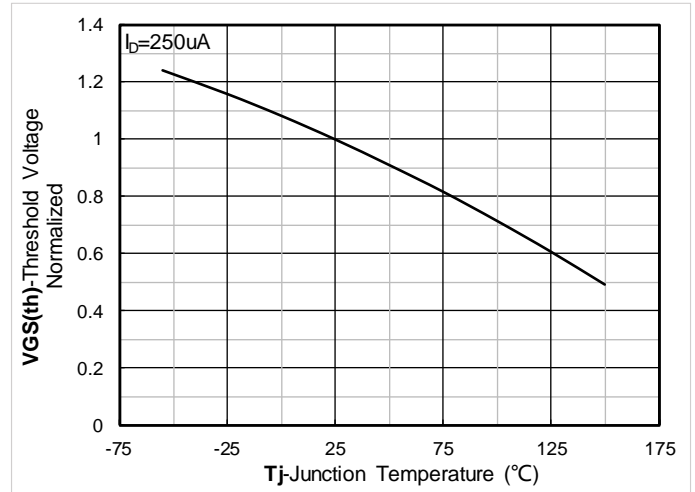

Figure 10. Normalized Threshold voltage

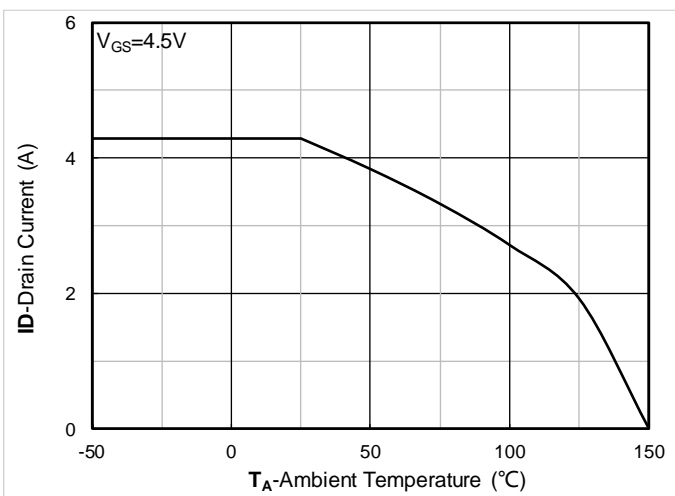

Figure 11. Current dissipation

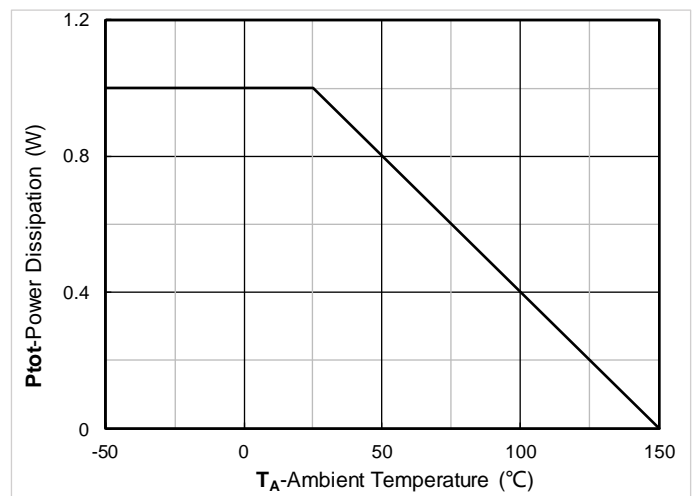

Figure 12. Power dissipation



# YJL3400AKJ

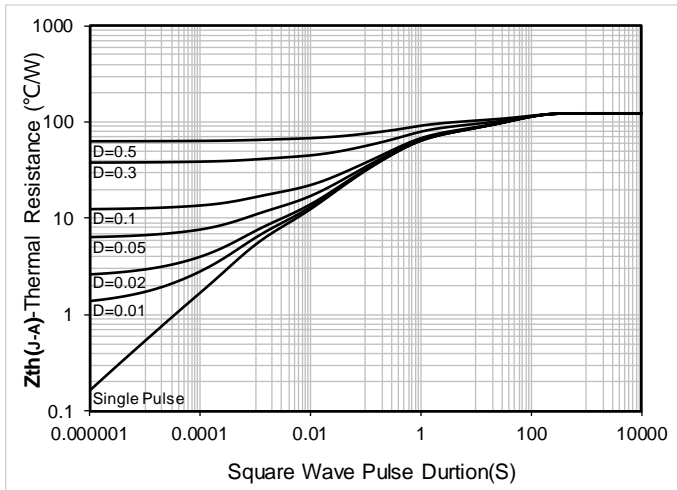

Figure 13. Maximum Transient Thermal Impedance

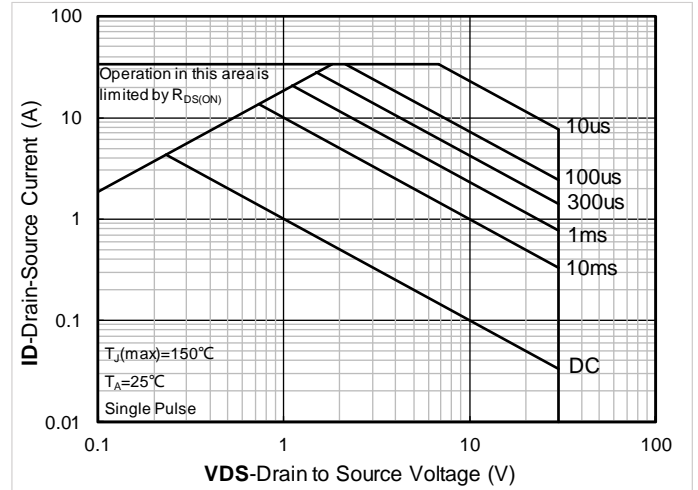

Figure 14. Safe Operation Area

## ■ Test Circuits & Waveforms

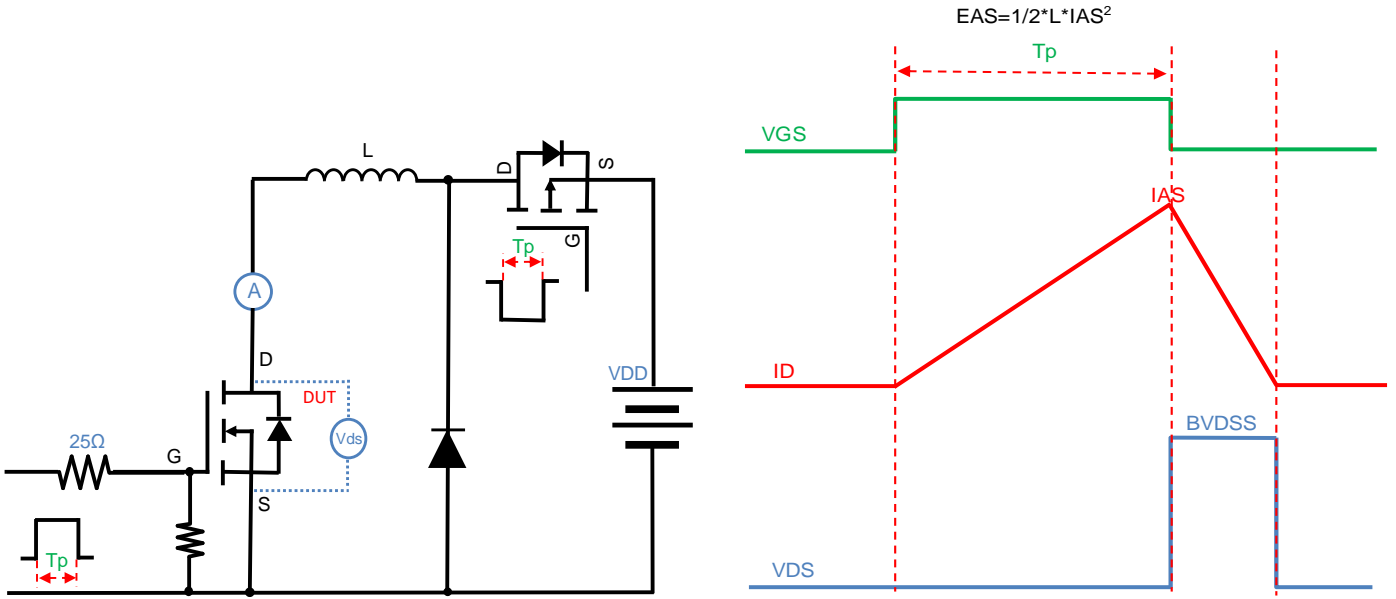

Figure A. Unclamped Inductive Switching (UIS) Test Circuit & Waveform

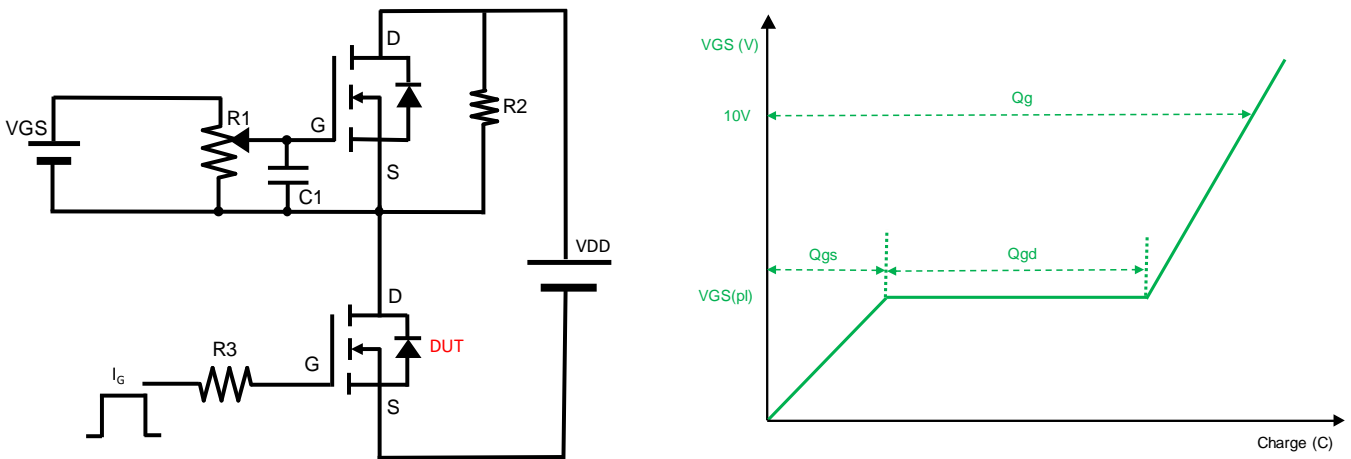

Figure B. Gate Charge Test Circuit & Waveform

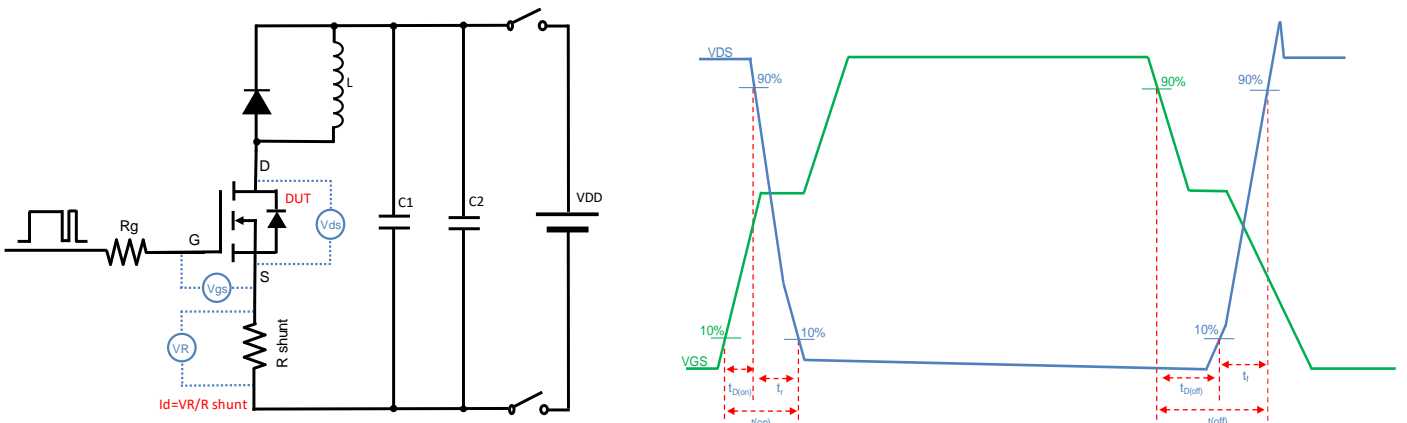

Figure C. Resistive Switching Test Circuit & Waveform

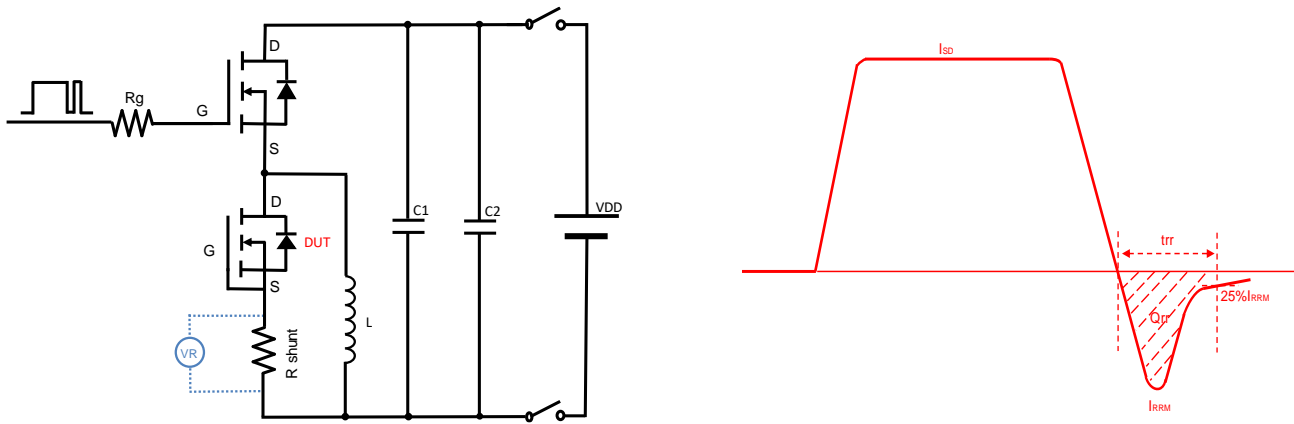
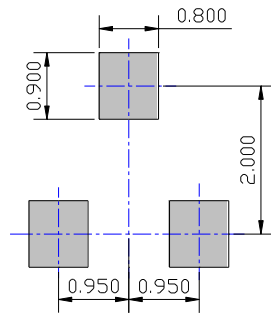
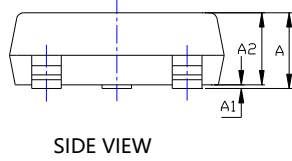
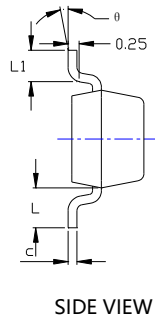
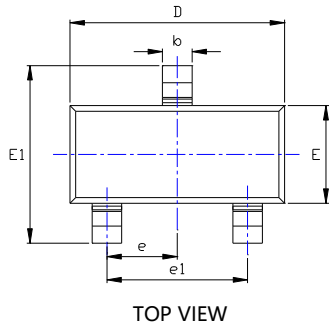

Figure D. Diode Recovery Test Circuit & Waveform



# YJL3400AKJ

## ■ SOT-23 Package information



UNIT: mm

SYMBOL	DIMENSIONS			
	INCHES		Millimeter	
	MIN.	MAX.	MIN.	MAX.
A	0.035	0.045	0.900	1.150
A1	0.000	0.004	0.000	0.100
A2	0.035	0.041	0.900	1.050
b	0.012	0.020	0.300	0.500
c	0.004	0.008	0.100	0.200
D	0.110	0.118	2.800	3.000
E	0.047	0.055	1.200	1.400
E1	0.089	0.100	2.250	2.550
e	0.037 TYP		0.950 TYP	
e1	0.071	0.079	1.800	2.000
L	0.022 REF		0.550 REF	
L1	0.012	0.020	0.300	0.500
θ	0°	8°	0°	8°

NOTE:  
 1. PACKAGE BODY SIZES EXCLUDE MOLD FLASH AND GATE BURRS.  
 2. TOLERANCE 0.1mm UNLESS OTHERWISE SPECIFIED.  
 3. THE PAD LAYOUT IS FOR REFERENCE PURPOSES ONLY.





## YJL3400AKJ

---

### Disclaimer

The information presented in this document is for reference only. Yangzhou Yangjie Electronic Technology Co., Ltd. reserves the right to make changes without notice for the specification of the products displayed herein to improve reliability, function or design or otherwise.

The product listed herein is designed to be used with ordinary electronic equipment or devices, and not designed to be used with equipment or devices which require high level of reliability and the malfunction of which would directly endanger human life (such as medical instruments, transportation equipment, aerospace machinery, nuclear-reactor controllers, fuel controllers and other safety devices), Yangjie or anyone on its behalf, assumes no responsibility or liability for any damages resulting from such improper use of sale.

This publication supersedes & replaces all information previously supplied. For additional information, please visit our website <http://www.21yangjie.com> , or consult your nearest Yangjie's sales office for further assistance.