

Small-Signal Fast Switching Diodes

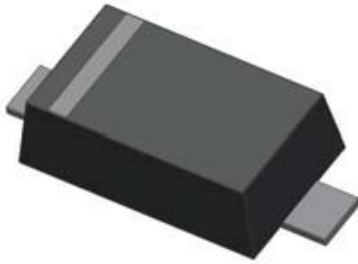

SOD523

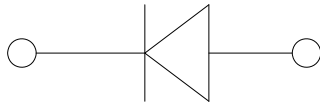

Features

- Epoxy meets UL-94 V-0 flammability rating and halogen free
- Moisture Sensitivity Level 1
- V_R 100V
- I_{FAV} 250mA
- Part no. with suffix "Q" means AEC-Q101 qualified

Typical Applications

- Extreme fast switches
- Automotive

Mechanical Data

- **Package:** SOD523
- **Terminals:** Tin plated leads, solderable per J-STD-002 and JESD22-B102
- **Polarity:** Cathode line denotes the cathode end
- **Marking:** 61

■ Maximum Ratings ($T_a=25^\circ\text{C}$ Unless otherwise specified)

PARAMETER	SYMBOL	UNIT	Conditions	VALUE
Repetitive peak reverse voltage	V_{RRM}	V		100
Reverse voltage	V_R	V	$I_R=100\mu\text{A}$	100
Peak forward surge current	I_{FSM}	A	Pulse width=1 μs	2
			Pulse width=1 s	1
Non-repetitive peak forward surge current	I_{FSM}	A	8.3ms half sine-wave	1
Average forward current	I_{FAV}	mA		250
Thermal Resistance Junction to Ambient	R_{thJA}	$^\circ\text{C/W}$		833
Power dissipation	P_D	mW		150
Maximum junction temperature	T_j	$^\circ\text{C}$		-55 to +150
Storage temperature range	T_{stg}	$^\circ\text{C}$		-55 to +150



BAS516Q

■Electrical Characteristics (T_a=25°C Unless otherwise specified)

PARAMETER	Symbol	UNIT	Conditions	Min	Max
Breakdown Voltage	V _R	V	I _R =100uA	100	
Forward Voltage	V _F	V	I _F =1mA		0.715
			I _F =10mA		0.855
			I _F =50mA		1.00
			I _F =150mA		1.25
Reverse Leakage Current	I _{R1}	nA	V _R =25V		30
	I _{R2}	uA	V _R =75V		1
Capacitance	C _j	pF	V _R =0V, f=1MHz; V _{sig} =50mV _{p-p}		4
Reverse Recovery Time	T _{rr}	ns	I _F =I _R =10mA, I _{rr} =0.1*I _R , R _L =100Ω		4

■Ordering Information (Example)

PREFERRED P/N	PACKING CODE	UNIT WEIGHT(g)	MINIMUM PACKAGE(pcs)	INNER BOX QUANTITY(pcs)	OUTER CARTON QUANTITY(pcs)	DELIVERY MODE
BAS516Q	F2	Approximate 0.002	8000	80000	320000	7" reel



■ Characteristics (Typical)

Fig.1: P_D-T_A

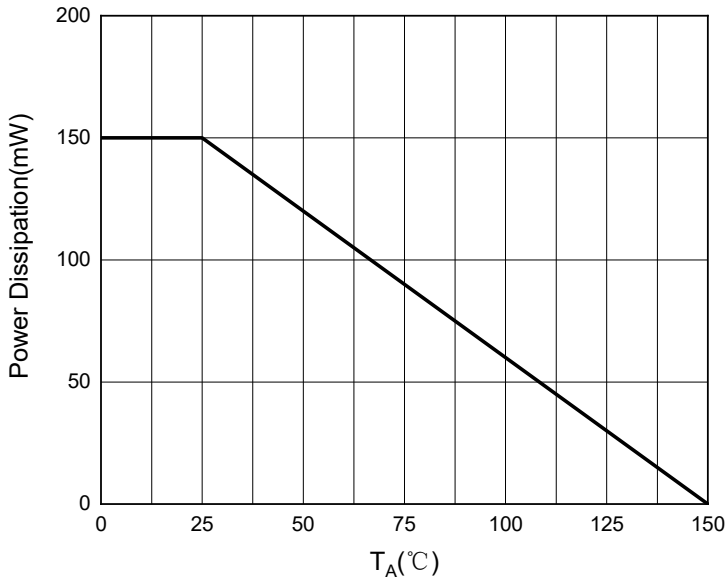

Fig.2: Capacitance Characteristics

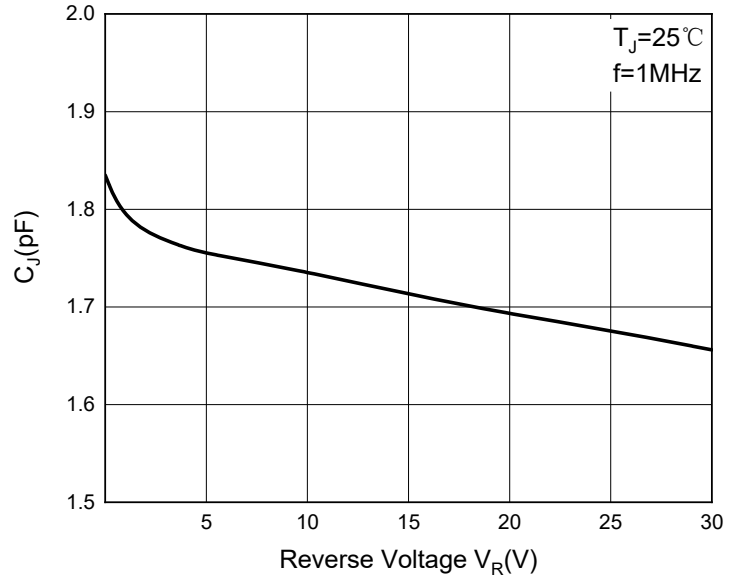

Fig3: Forward Characteristics

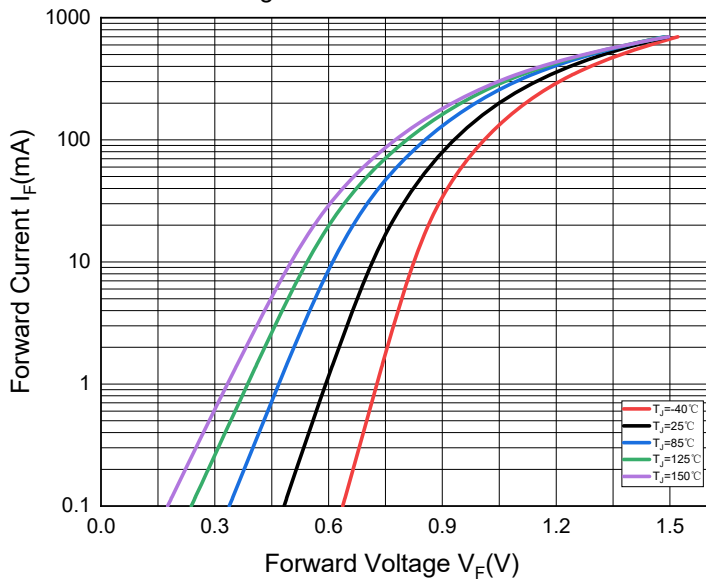
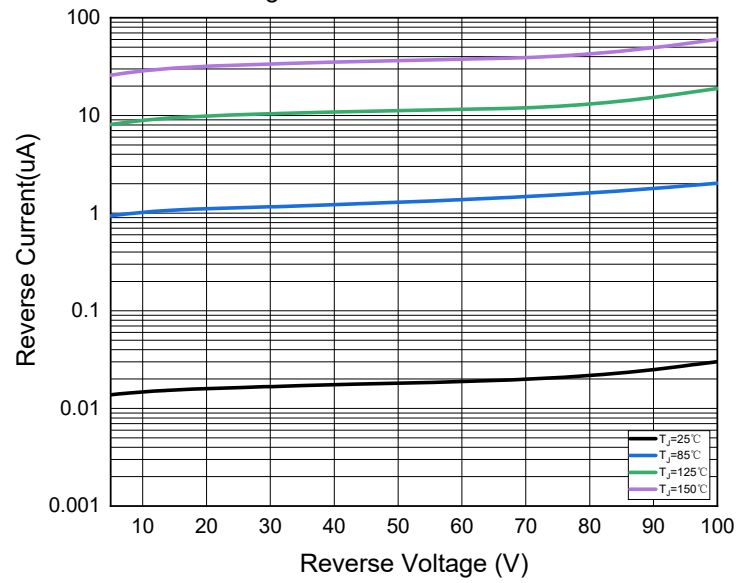

Fig.4: Reverse Characteristics





BAS516Q

■ Outline Dimensions

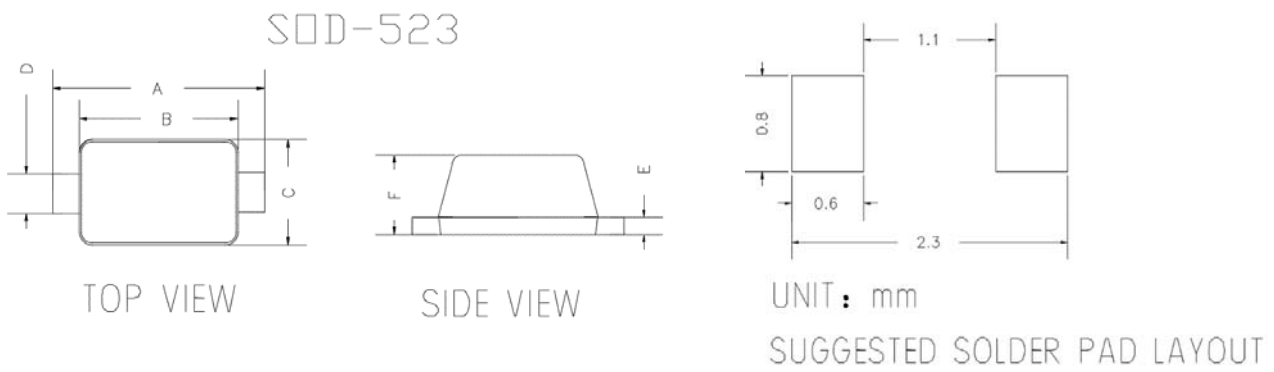

DIMENSIONS				
DIM	INCHES		MM	
	MIN	MAX	MIN	MAX
A	0.059	0.067	1.500	1.700
B	0.043	0.051	1.100	1.300
C	0.028	0.035	0.700	0.900
D	0.010	0.014	0.250	0.350
E	0.002	0.008	0.050	0.200
F	0.020	0.028	0.500	0.700

■ Marking Information

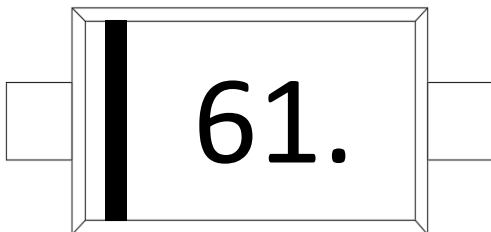

Note:

1. All marking is at middle of the product body
2. All marking is in laser marking
3. Body color: Black



BAS516Q

Disclaimer

The information presented in this document is for reference only. Yangzhou Yangjie Electronic Technology Co., Ltd. reserves the right to make changes without notice for the specification of the products displayed herein to improve reliability, function or design or otherwise.

The product listed herein is designed to be used with automotive electronics, are not designed for use in medical, life-saving, lifesustaining, or military, Yangjie or anyone on its behalf, assumes no responsibility or liability for any damages resulting from such improper use of sale.

This publication supersedes & replaces all information previously supplied. For additional information, please visit our website [http:// www.21yangjie.com](http://www.21yangjie.com) , or consult your nearest Yangjie's sales office for further assistance.